



Dynion 3R85

 Instructions for use

1	Notes regarding the document	4
1.1	Explanation of warning symbols.....	4
1.2	Meanings of pictograms in the illustration.....	4
1.3	Characteristics (product, document).....	5
1.4	Document versions.....	6
2	Product description	7
3	Intended use	7
3.1	Indications for use.....	7
3.2	Area of application.....	7
3.3	Combination possibilities.....	8
3.4	Environmental conditions.....	9
3.5	Reuse and lifetime.....	10
4	General safety instructions	10
5	Scope of delivery	11
6	Technical data	12
7	Preparing the product for use	14
7.1	Information on fabrication of a prosthesis.....	14
7.2	Manufacturing the bench alignment.....	14
7.3	Optimising the static alignment.....	19
7.4	Optimising during dynamic fitting.....	21
7.4.1	Notices regarding dynamic fitting.....	21
7.4.2	Overview of adjustment possibilities.....	22
7.4.3	Checking the initial settings for the dynamic fitting.....	29
7.4.4	Switching between the stance phase and swing phase.....	31
7.4.5	Exercises and adjustments.....	33
7.5	Attaching the cosmetic cover.....	43
7.6	Finishing the prosthesis.....	45
8	Use	46
8.1	Information for use.....	46
8.2	Cleaning.....	48
9	Maintenance	49
10	Disposal	50
11	Legal information	51
11.1	Liability.....	51
11.2	CE conformity.....	51

1 Notes regarding the document

INFORMATION

Date of last update: 2022-05-07

- ▶ Please read this document carefully before using the product and observe the safety notices.
- ▶ Instruct the user in the safe use of the product.
- ▶ Please contact the manufacturer if you have questions about the product or in case of problems.
- ▶ Report each serious incident related to the product to the manufacturer and to the relevant authority in your country. This is particularly important when there is a decline in the health state.
- ▶ Please keep this document for your records.





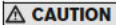





This document and the product are intended exclusively for the fabrication of a prosthesis by qualified personnel with technical knowledge of lower limb prosthetics.

1.1 Explanation of warning symbols

 **CAUTION** Warning regarding possible risks of accident or injury.

 **NOTICE** Warning regarding possible technical damage.

1.2 Meanings of pictograms in the illustration

	Numbering for the illustrations		Reference to the section for the illustration
	Numbering for a defined sequence		Numbering for the parts of an illustration
	Right		Wrong
	Observe the safety notice in the section!		Risk of falling
	Replace		Movement against a stop

1.3 Characteristics (product, document)

1: The following characteristics are important for identification:

- ①: 3R85 [product reference number]
- ②: YYYYWWNNNN [product serial number: YYYY (year of manufacture); WW (calendar week); NNNN (number)]
- ③: 647G1166=all_INT-VV-YYMM [standard line for the document: 647G1166=all_INT (reference number for the document); VV (version number); YYMM (publication date) – YY (year); MM (month)]

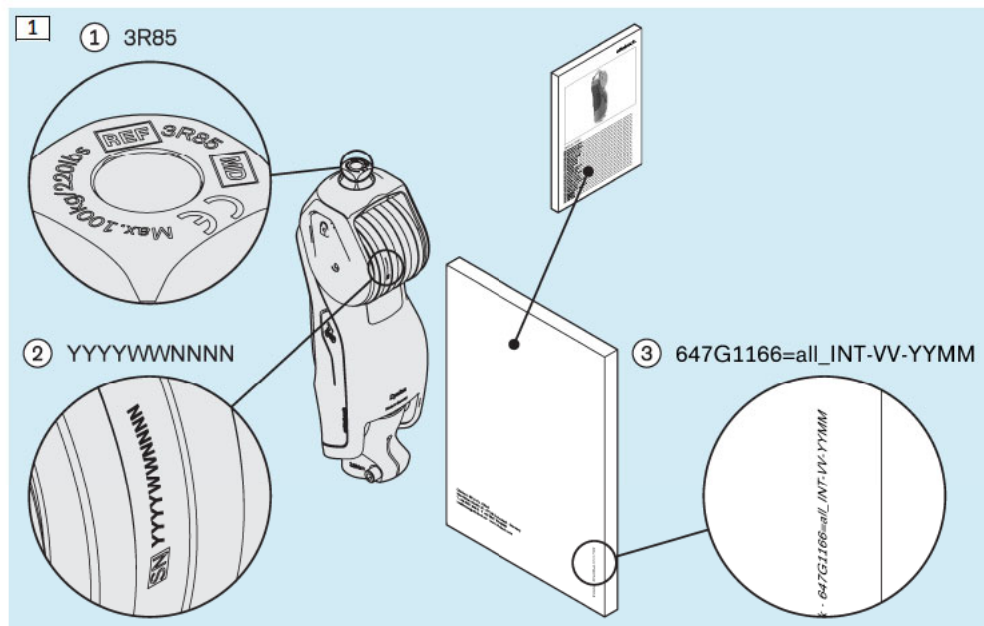

1.4 Document versions

2: The document is available in the following versions:

- ①: 647G1166=all_INT (document reference number with all available languages)
All illustrations in this document are found at the beginning. They are followed by the texts in all languages.
This printed document is included in the scope of delivery.
This document is available in electronic form (PDF file).
- ②: 647G1166=XX_INT (document reference number as single-language version)
647G1166=en_INT (example of single-language version in en = English)
All illustrations in this document are found in the respective sections.
This document is available in electronic form (PDF file).
- ③ XX (variable for the language codes of the languages in which the single-language version is available)

The documents in electronic form are available as follows:

- Download via the manufacturer's download portal under the QR code and link provided



<https://product-documents.ottobock.com/IFU/INT/3R85/647G1166/11/O/S/F>

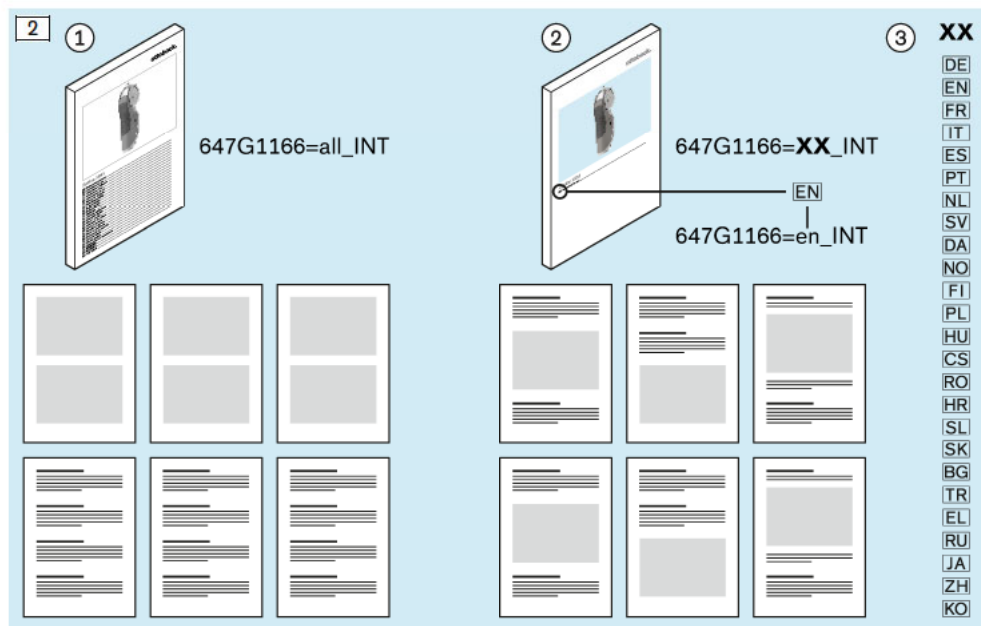

The following additional documents are available in electronic form (PDF file):

- 646D1504=de_INT (Kurzanleitung)
- 646D1504=en_INT (Quick reference guide)

2 Product description

The product (3R85) has the following key features:

- Monocentric prosthetic knee joint with rotation hydraulics
- Product components for stance phase stability:
 - Adjustable stance phase flexion resistance (hydraulic damping)
 - Adjustable switching threshold to deactivate stance phase flexion resistance at the end of the stance phase
 - Modes (switching by the patient):
 - Standard mode – stance phase flexion resistance activated
 - Cycling mode – stance phase flexion resistance deactivated
 - Lock (activation and deactivation by the patient)
- Product components for swing phase control:
 - Adjustable swing phase flexion resistance (hydraulic damping)
 - Adjustable swing phase extension resistance (hydraulic damping)
 - Hydraulic unit with extension assist function (spring force)

3 Intended use

3.1 Indications for use

The product is intended exclusively for lower limb exoprosthetic fittings.

3.2 Area of application

 CAUTION	
Excessive strain on the product Fall due to breakage of load-bearing components ► Only use the product according to its allowable field of application.	
Allowable field of application (3R85)	
Recommended mobility grade: 3 + 4	Everyday prosthesis
Allowable body weight: ≤ 100 kg	

3.3 Combination possibilities

⚠ CAUTION

Improper combination of prosthetic components

Injuries, malfunctions or product damage due to unallowable combination of prosthesis components

- Based on the instructions for use of all prosthetic components used, verify that they may be combined with each other and are approved for the patient's area of application.

INFORMATION

In a prosthesis, all prosthetic components have to meet the patient's requirements regarding the amputation level, body weight, activity level, environmental conditions and field of application.

3: Recommended combinations | Unallowable combinations

- Note the image for the recommended combinations and unallowable combinations.

3

4R57=WR 4R57=WR-ST 3R85

7E9 7E7

Greissinger plus 1A30*

Empower 1A1-1* 25-27

Meridium 1B1* 24-25

Terion 1C10*

Trias 1C30*

C-Walk 1C40*

Taleo, Taleo LP 1C50*, 1C53*

Triton 1C60* 21-28

Triton Vertical Shock 1C61* 21-28

Triton Harmony 1C62* 21-28

Triton Low Profile 1C63* 21-28

Triton Heavy Duty 1C64* 21-28

Triton side flex 1C68* 21-28

Dynamic Motion 1D35*

Actixon 1E56*

7E10*

3R85

3R85

Empower 1A1-1* 28-30

Meridium 1B1* 26-29

Triton 1C60* 29-30

Triton Vertical Shock 1C61* 29-30

Triton Harmony 1C62* 29-30

Triton Low Profile 1C63* 29-30

Triton Heavy Duty 1C64* 29-30

Triton side flex 1C68* 29-30

3.4 Environmental conditions

CAUTION

Use under unallowable environmental conditions

Fall due to damaged product

- ▶ Do not expose the product to unallowable environmental conditions (see the table "Unallowable environmental conditions" in this section).
- ▶ If the product was exposed to unallowable environmental conditions, take suitable steps (e.g. cleaning, repair, replacement, inspection by the manufacturer or a specialist workshop etc.).

Allowable environmental conditions

Temperature range:

Storage + Transportation (in original packaging): -20 °C – +60 °C

Always store in a dry place.

Use: -10 °C – +45 °C

Relative humidity: 20 % – 90 %

Contact with drops of water (fresh water, light rain)

Drying is required after contact.

Contact with soapy water in the form of splashed water (showering); contact with perspiration

Submersion in chlorinated water (e.g. pool) – maximum depth: 2 m

Rinsing with clean fresh water and drying is required after contact.

Submersion in salt water with permissible salt content

- Salt content: max. 3.5 %
- Maximum depth: pool: 1 m, ocean: 0.5 m

Thorough rinsing with or immersing in clean fresh water and drying is required after contact (section "Cleaning" – see page 48).

An inspection by qualified personnel (prosthesis manufacturer) is required after use (days per year: 14).

An inspection by service (prosthetic knee joint manufacturer) is required in case of damage and functional limitations.

Contact with dust, foam cover particles, drifting sand (e.g. walking on the beach)

Regular cleaning is required.

Contact with salty air – condensing

Rinsing with clean fresh water and drying is required after contact.

UV resistant

Cleaning with damp cloth (fresh water + commercially available, solvent-free cleaning agent)

Unallowable environmental conditions

Contact with hygroscopic particles (example: talcum); contact with large amounts of sand and dust (e.g. burying, kneeling in sand, construction site); contact with acids; contact with urine;

Submersion in salt water with excessive salt content

- Salt content: > 3.5 % – e.g. brine bath

Cleaning agents and disinfectants with solvents, chlorine and phosphate

High water pressure (e.g. diving, jumping into water)

3.5 Reuse and lifetime

CAUTION

Reuse on another patient

Fall due to loss of functionality as well as damage to the product

- ▶ Only use the product for a single patient.

CAUTION

Exceeding the lifetime

Fall due to change in or loss of functionality and damage to the product

- ▶ Ensure that the maximum lifetime defined in this section is not exceeded.

This prosthetic component has been load tested by the manufacturer according to ISO 10328. The maximum lifetime is 5 years.

4 General safety instructions

CAUTION

Reaching into the area of the joint mechanism

Pinching of limbs (e.g. fingers) and the skin due to uncontrolled joint movement

- ▶ Do not reach into the joint mechanism during use.
- ▶ Close attention is required during assembly and adjustment tasks.

CAUTION

Mechanical damage to the product

Risk of injury due to change in or loss of functionality

- ▶ Use caution when working with the product.
- ▶ If the product is damaged, check it for proper function and readiness for use.
- ▶ In case of changes in or loss of functionality, do not continue using the product (see "Signs of changes in or loss of functionality during use" in this section).
- ▶ Take any necessary measures (e.g. repair, replacement, inspection by the manufacturer's customer service, etc.).

Signs of changes in or loss of functionality during use

Changes in functionality can manifest themselves, for example, through a changed gait (swing phase, stance phase), incomplete extension, stiffness and the development of noise.

5 Scope of delivery

4: Check the scope of delivery against the illustrations.

Only product components with reference numbers in the illustration can be reordered separately. A product component without a reference number in the illustration cannot be reordered separately.

Reference numbers in brackets "()" indicate which alternative products can be reordered as replacements for the included product component.

In the illustration, a reference number shown in bold stands for a spare parts package in which the product components shown in the frame can be reordered.

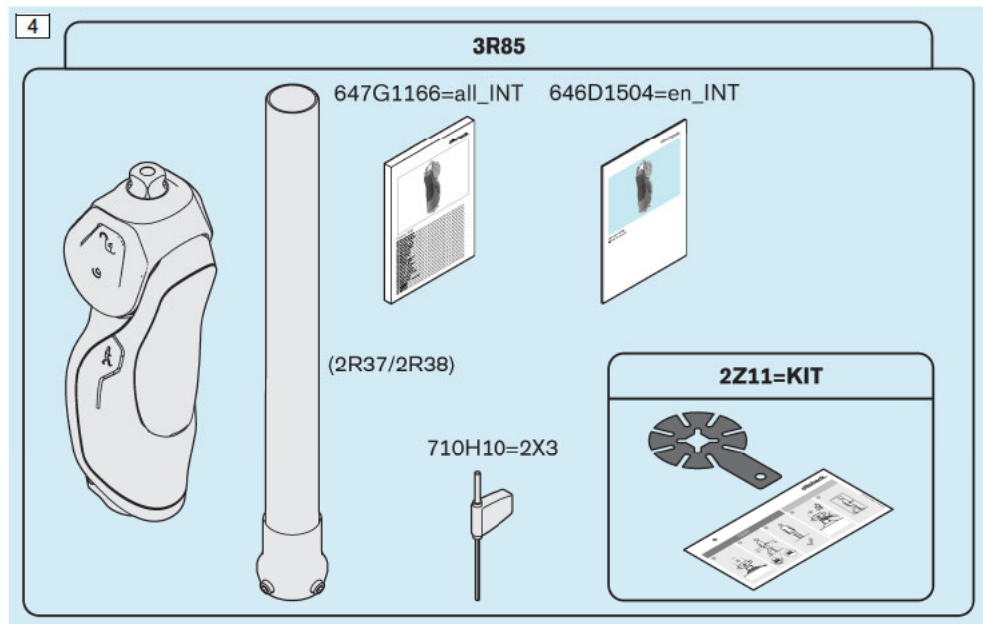

6 Technical data

[5] + [6]: See the illustrations for the technical data.

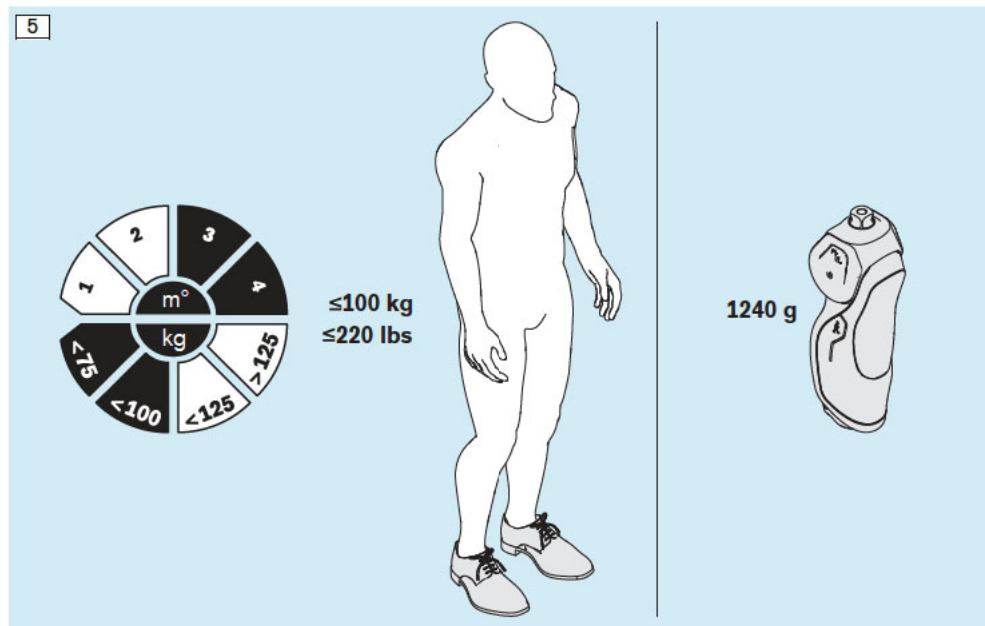

- ①: Build height; ②: Proximal build height; ③: Distal build height;
 ④: System height; ⑤: Proximal system height; ⑥: Distal system height

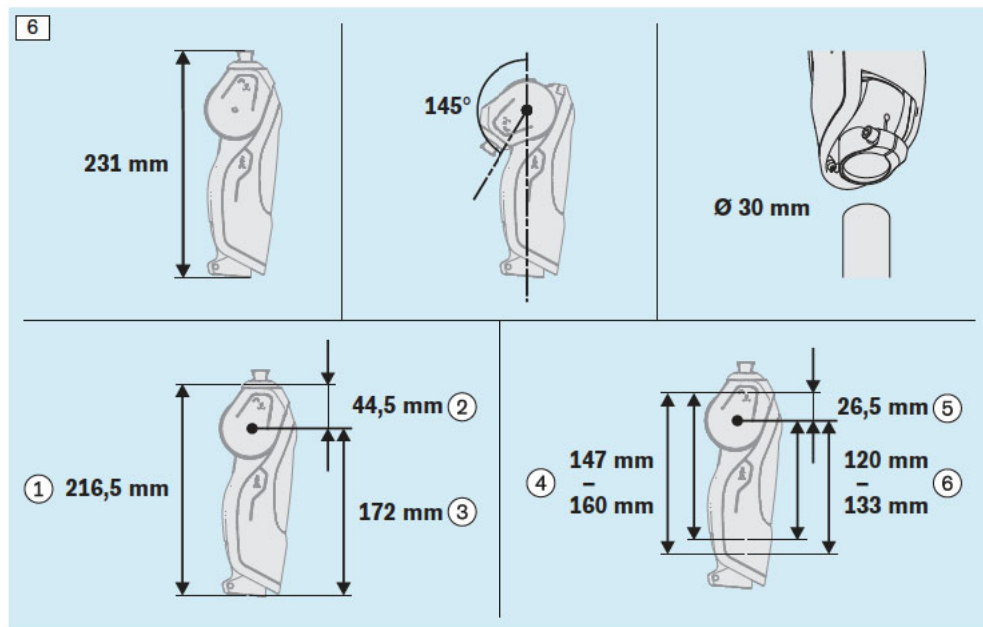

7 Preparing the product for use

7.1 Information on fabrication of a prosthesis

⚠ CAUTION

Incorrect alignment, assembly or adjustment

Injury due to incorrectly installed or adjusted as well as damaged prosthetic components
► Observe the alignment, assembly and adjustment instructions.

⚠ CAUTION

Initial use of the prosthesis by the patient

Fall due to lack of patient experience, incorrect alignment or incorrect adjustment of the prosthesis

► For the safety of the patient, use a suitable device (e.g. parallel bars, handrail, wheeled walker) during initial standing and walking.

7.2 Manufacturing the bench alignment

- [7] + [8]: **CAUTION!** To enable the patient to stand safely, align the prosthesis using the alignment images as well as the instructions for use of all prosthetic components used.
- During activation and deactivation of the lock, push the prosthetic knee joint against the extension stop.
- Perform the bench alignment of the prosthesis with the prosthetic knee joint locked.
- **INFORMATION:** The posterior section of the prosthetic knee joint can be used as a flexion stop for the prosthetic socket.
- **NOTICE!** Design the prosthetic socket so that nothing made of metal presses against the posterior section of the prosthetic knee joint.

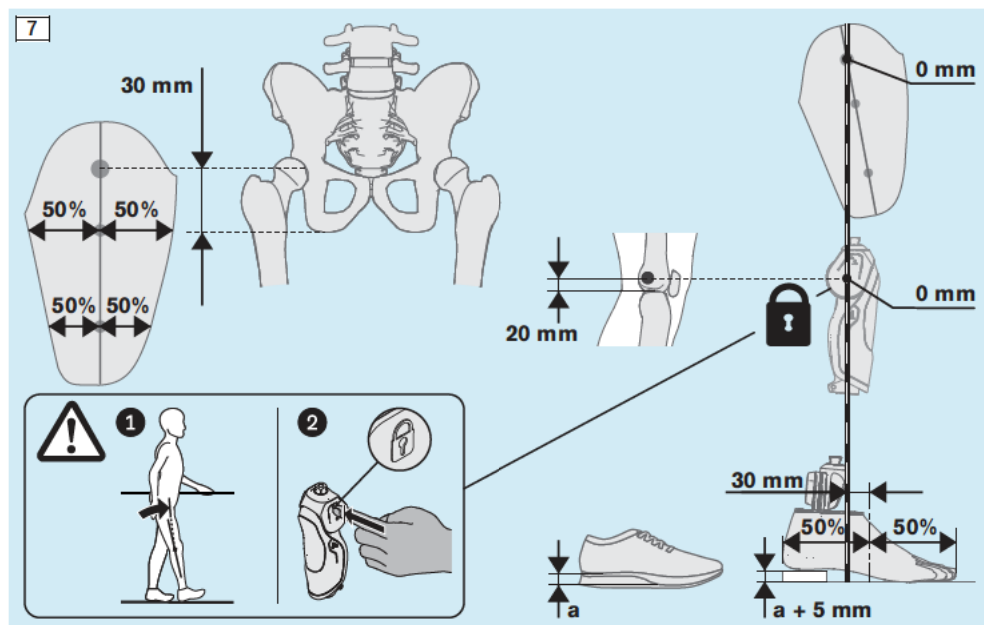

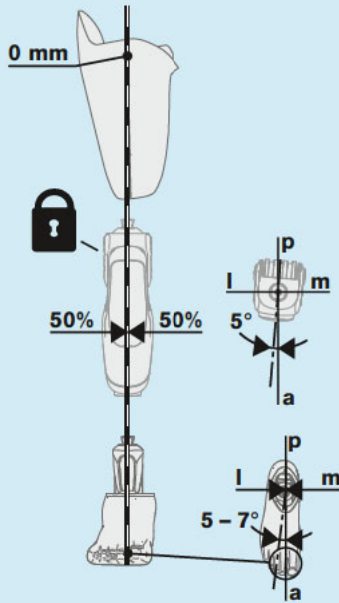

Use 2Z11=KIT

INFORMATION: The connection area of the prosthetic knee joint can be protected against scratches with the protective film of the 2Z11=KIT during alignment in the workshop and testing in the trial fitting area.

- ▶ Use the protective film as illustrated in the accompanying document for the 2Z11=KIT.
- ▶ Remove the protective film before the patient leaves the fitting area.

Adapter inserts

- ▶ **9**: Mount the adapter inserts shown in the illustration when using an alignment apparatus.
 - **1**: The prosthetic knee joint reference numbers shown in square brackets are marked on the adapter inserts. The adapter insert reference numbers and mm dimensions in the round brackets are not found on the adapter inserts.

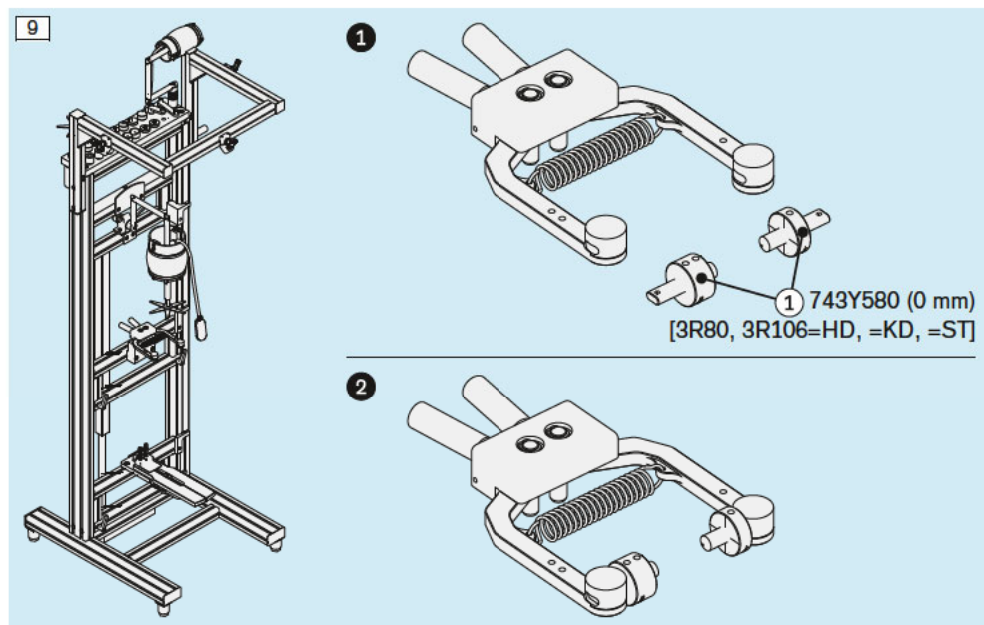

Installing the tube adapter

CAUTION

Improper assembly of the screw connections

Risk of injury due to breakage or loosening of the screw connections

- ▶ Clean the threads before every installation.
- ▶ Apply the specified torque values.
- ▶ Follow the instructions for thread lock.

CAUTION

Incorrect processing of the tube

Fall due to damage to the tube

- ▶ Do not clamp the tube in a vice.
- ▶ To shorten the tube, use only a tube cutter or a cutting device.
- ▶ Deburr the inside and outside of the cut edge with the tube deburrer.

CAUTION

Incorrect assembly of the tube

Risk of injury due to breakage of load-bearing components

- ▶ Clean the contact surfaces of the tube and the tube adapter using a degreasing cleaning agent.
- ▶ Note the values identified as permissible and impermissible in the illustration for positioning the tube in the tube adapter.

► **10: CAUTION!** Position and clamp the tube adapter only as shown in the illustration.

→ ①: Impermissible value: > 13 mm

→ ②: Permissible value: 0 – 13 mm

→ ③: Recommended value: 0 mm

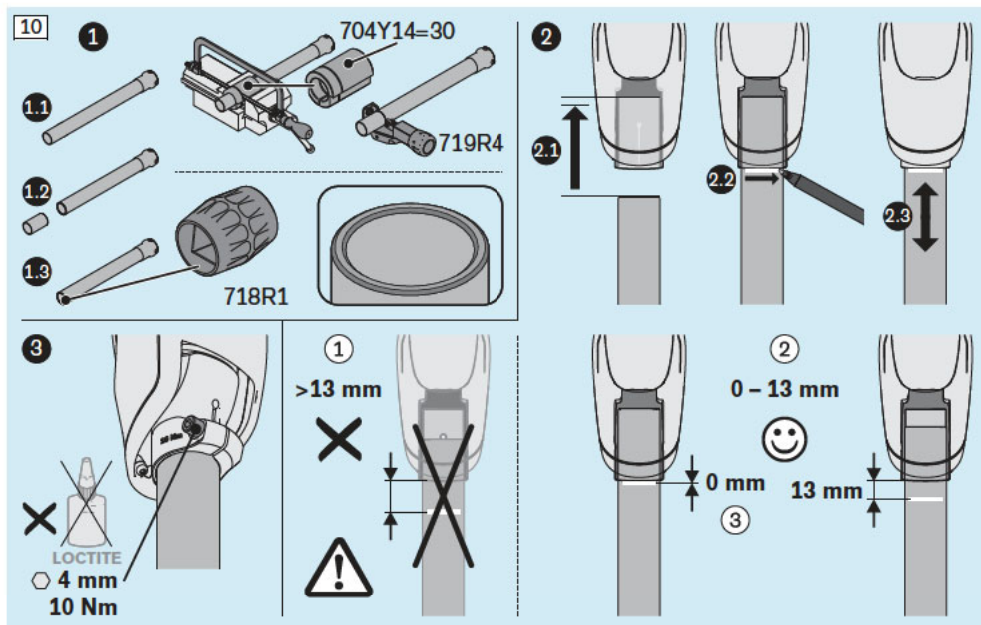

7.3 Optimising the static alignment

INFORMATION: Additional technical knowledge is provided by the instructions for use of the measuring apparatus being used, the TF alignment poster and the Ottobock seminars.

The 743L500 3D L.A.S.A.R. Posture measuring apparatus is needed to optimise the static alignment.

The following optimisation methods are available:

- ①: Optimisation with 3D mode activated
- ②: Optimisation with 3D mode deactivated

The optimisation method ② can be used as an optional second step.

With the 743L100 L.A.S.A.R. Posture, optimisation is possible only based on the values of the optimisation method ②.

11: 1: Optimisation with 3D mode activated

- ▶ Optimise the static alignment so the patient stands in a relaxed position, the values for the reference points shown in the illustration are met and the following points are observed:
 - ①: 3D mode is activated (3D symbol – colour: green).
 - Sequence for optimisation in reference to the planes:
 - ①.1: Sagittal plane – ①.2: Frontal plane
 - ②: The prosthetic knee joint is in extension. The lock is activated.
 - ③: The reference line lies on the sagittal reference point of the prosthetic knee joint (pivot point).
 - ④: The reference points are in the centre (50 : 50: pyramids of the prosthetic knee joint and the prosthetic foot, shoes).
 - ⑤: The extension of the reference line points to the reference point (anterior superior iliac spine).
 - ⑥: The reference line lies on the frontal reference point of the prosthetic knee joint (pyramid).

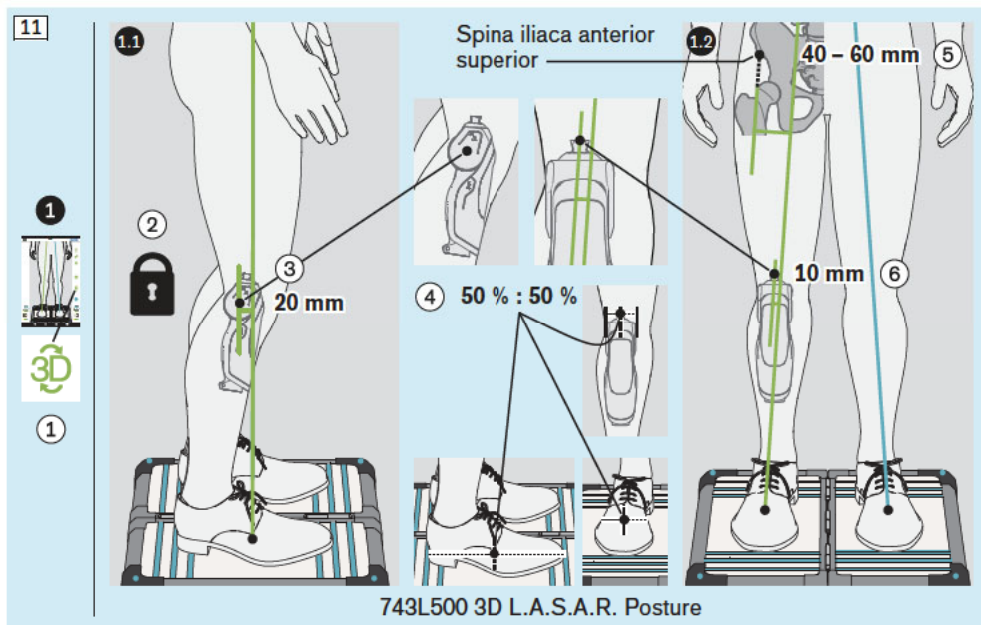

12: 2: Optimisation with 3D mode deactivated

- ▶ Optimise the static alignment so the values for the reference points shown in the illustration are met and the following points are observed:
 - ①: 3D mode is deactivated (3D symbol – colour: dark grey).
 - Sequence for optimisation in reference to the planes:
 - 2.1: Sagittal plane – 2.2: Frontal plane
 - ②: The prosthetic knee joint is in extension. The lock is activated.
 - ③: The reference line lies on the sagittal reference point of the prosthetic knee joint (pivot point).
 - ④: The reference points are in the centre (50 : 50: pyramids of the prosthetic knee joint and the prosthetic foot, shoes).
 - ⑤: The extension of the reference line points to the reference point (anterior superior iliac spine).
 - ⑥: The reference line lies on the frontal reference point of the prosthetic knee joint (pyramid).
 - ⑦: The extension of the reference line points to the reference point (pyramid).

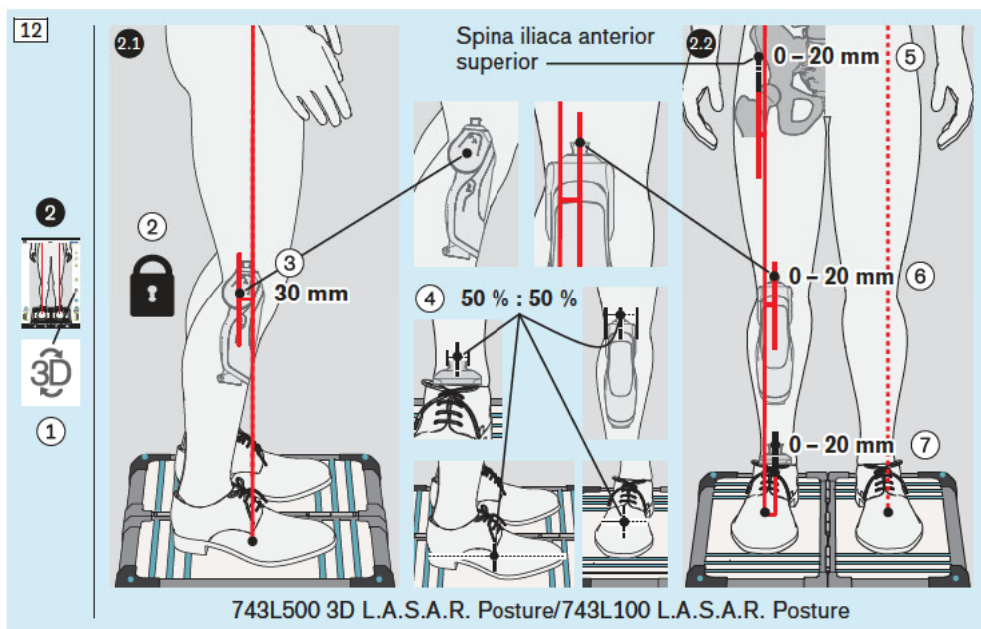

7.4 Optimising during dynamic fitting

7.4.1 Notices regarding dynamic fitting

⚠ CAUTION

Adjusting the Settings

Fall due to incorrect or unfamiliar settings

- ▶ Only adapt the settings to the patient gradually.
- ▶ Explain the effects of the adjustments on the use of the prosthesis to the patient.

7.4.2 Overview of adjustment possibilities

13: ①: Stance phase flexion resistance; ②: Swing phase flexion resistance; ③: Swing phase extension resistance; ④: Switching threshold

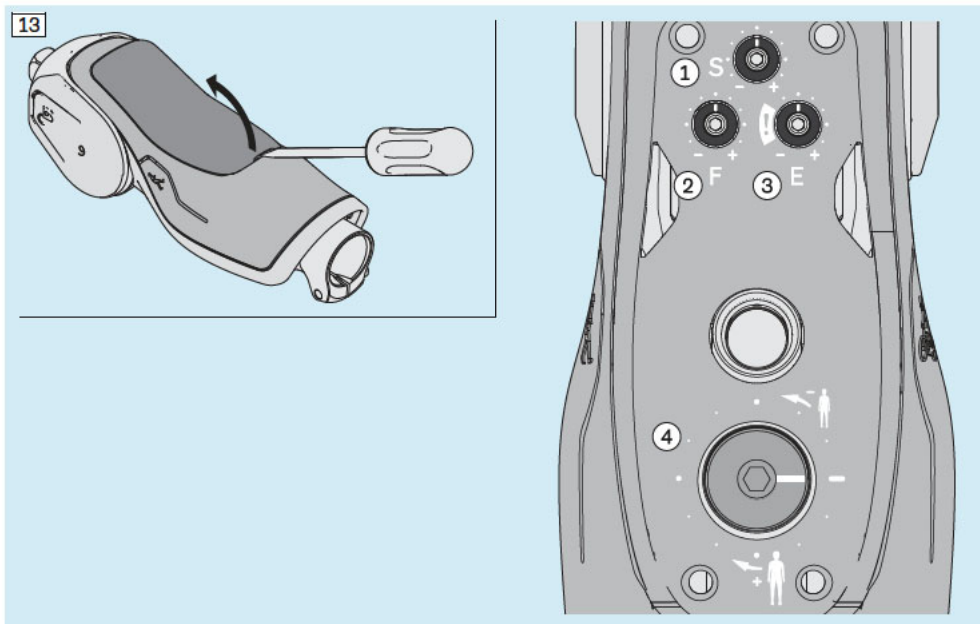

Stance phase flexion resistance

14: ①: Adjustment range; ②: Decrease stance phase flexion resistance; ③: Increase stance phase flexion resistance

14

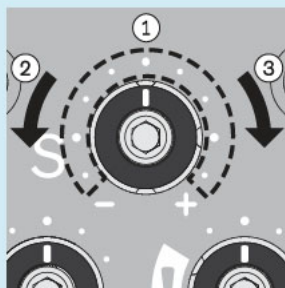
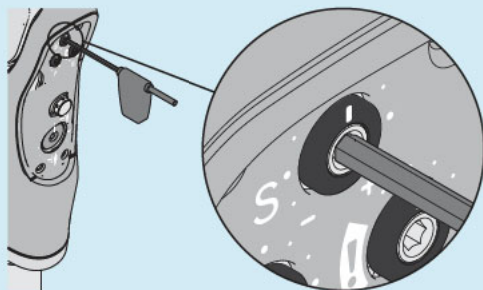

Switching threshold

15: ①: Adjustment range; ②: Reduce switching threshold (lower weight required to initiate the swing phase); ③: Increase switching threshold (higher weight required to initiate the swing phase)

INFORMATION: The weight to initiate the swing phase refers to the force used to push the prosthetic knee joint into hyperextension so that the stance phase flexion resistance is deactivated again at the end of the stance phase, and therefore does not slow down or prevent the flexion movement into the swing phase. Aside from the patient's weight and height, the size and stiffness of the prosthetic foot, the prosthetic alignment and the individual gait dynamics also play a role here.

15

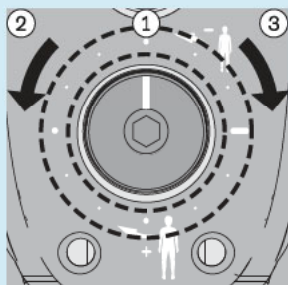
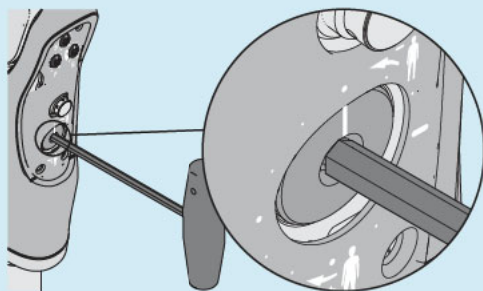

Swing phase flexion resistance

16: ①: Adjustment range; ②: Decrease swing phase flexion resistance; ③: Increase swing phase flexion resistance

16

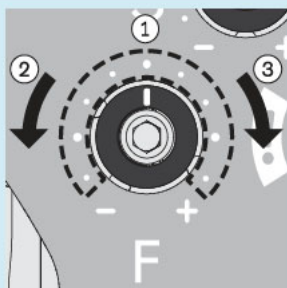
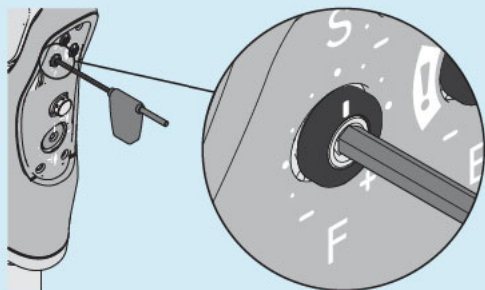

Swing phase extension resistance

17: ①: Adjustment range; ②: Decrease swing phase extension resistance; ③: Increase swing phase extension resistance

17

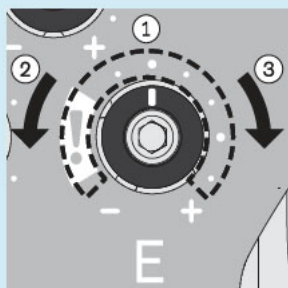
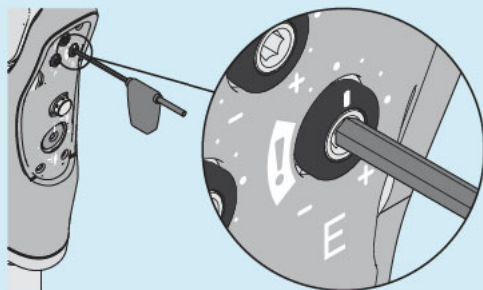

Lock

- **18**: Activate the lock as shown in the illustration for use in wet areas (e.g. showering and swimming) and relaxed standing. Deactivate the lock for walking. Put weight on the prosthetic knee joint and push against the extension stop when activating and deactivating.
- ①: Activate lock
INFORMATION: Activate by pushing against the stop.
- ②: Deactivate lock
INFORMATION: Deactivate by pushing against the stop.
- **CAUTION!** To avoid dangers and product damage, cycling mode must also be activated in addition to the lock for use in water. Note the instructions under the heading "Use in water" in the section "Information for use" (see page 46).

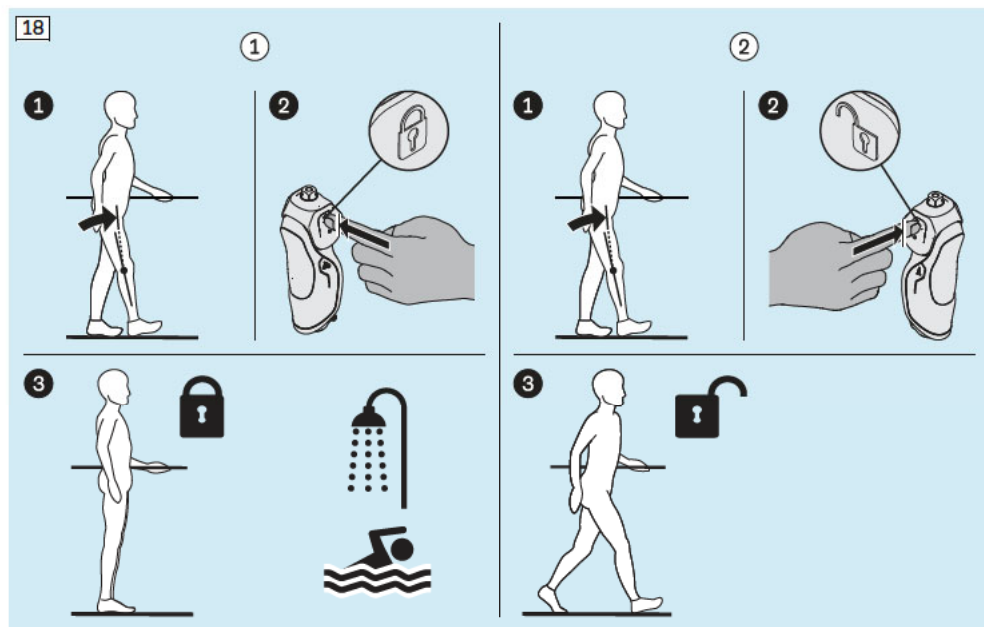

Cycling mode

- **19:** Activate cycling mode as shown in the illustration for cycling and similar movement sequences. For normal walking, switch to standard mode by deactivating cycling mode.
- ①: Activate cycling mode
INFORMATION: Activate by pushing against the stop beyond an initial resistance. Stance phase flexion resistance is deactivated by activating cycling mode.
 - ②: Deactivate cycling mode
INFORMATION: Deactivate by pushing against the stop. Stance phase flexion resistance is activated by deactivating cycling mode.

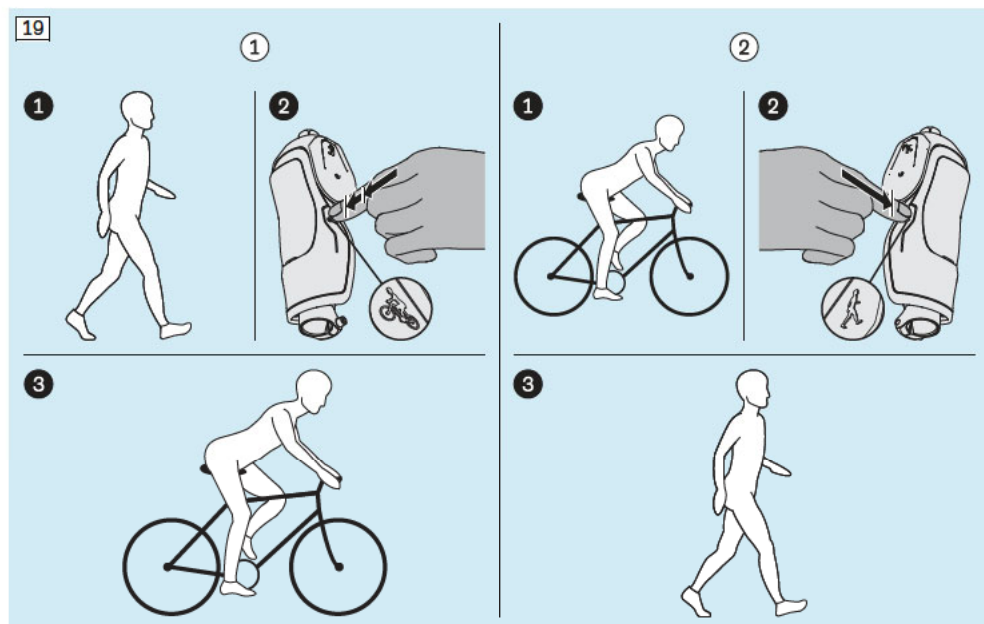

7.4.3 Checking the initial settings for the dynamic fitting

- Before the dynamic fitting, check the required initial settings listed below and correct any deviations.

20: ①: Stance phase flexion resistance; ②: Switching threshold to initiate the swing phase

INFORMATION

②: When adjusting the switching threshold to initiate the swing phase, ① it is necessary to first turn back anticlockwise to the stop ② and then turn clockwise to the specified position.

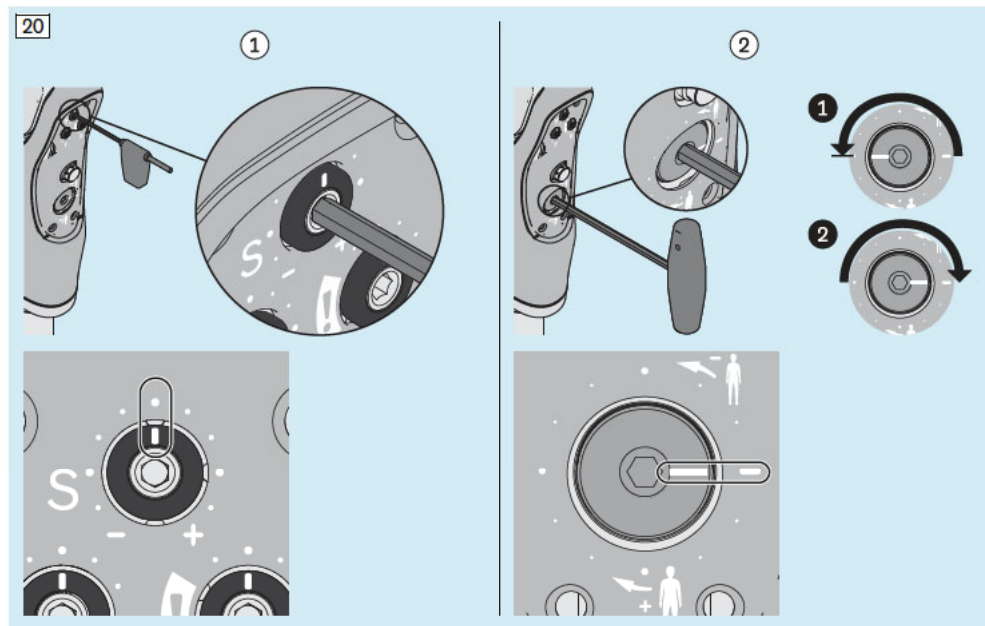

21: ①: Swing phase flexion resistance; ②: Swing phase extension resistance

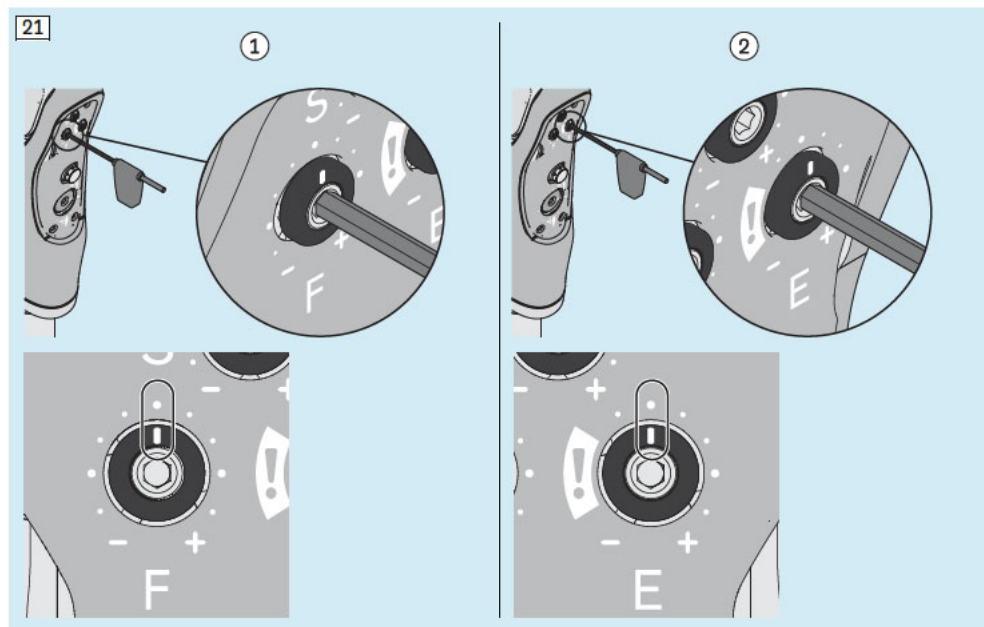

22: ①: Lock (deactivated); ②: Stance phase flexion resistance (activated)

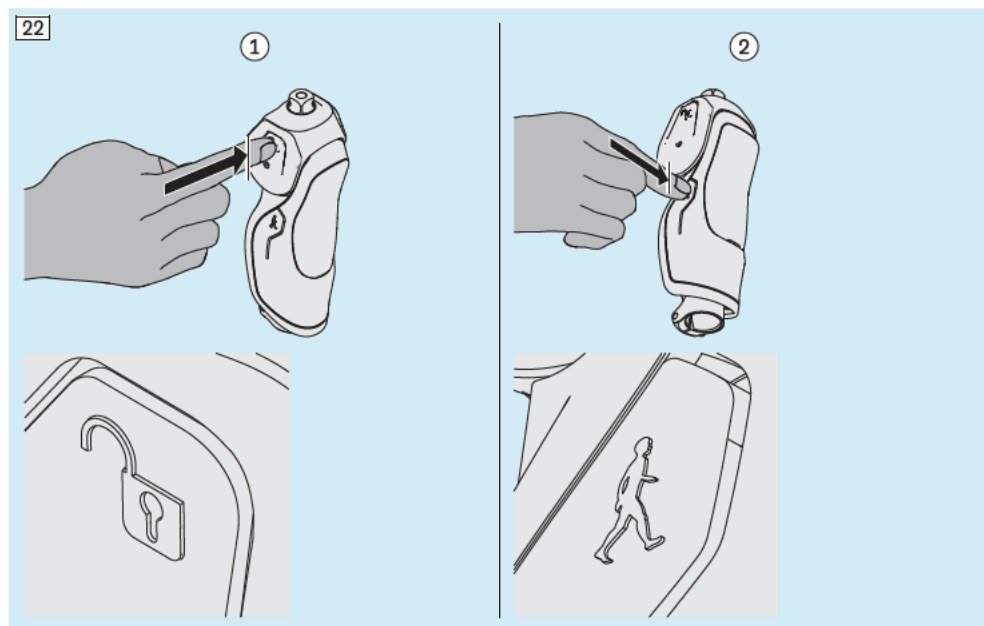

7.4.4 Switching between the stance phase and swing phase

23: ①: Stance phase flexion resistance deactivated; ②: Stance phase flexion resistance activated

①: When the forefoot is loaded at the end of the stance phase, the prosthetic joint is pushed into hyperextension. During subsequent initiation of a knee flexion moment, stance phase flexion resistance is deactivated and swing phase flexion resistance is activated.

②: Stance phase flexion resistance is activated again in the swing phase when switching from flexion to extension.

③: The prosthetic knee joint is in extension at heel strike. Stance phase flexion resistance is activated, securing the knee.

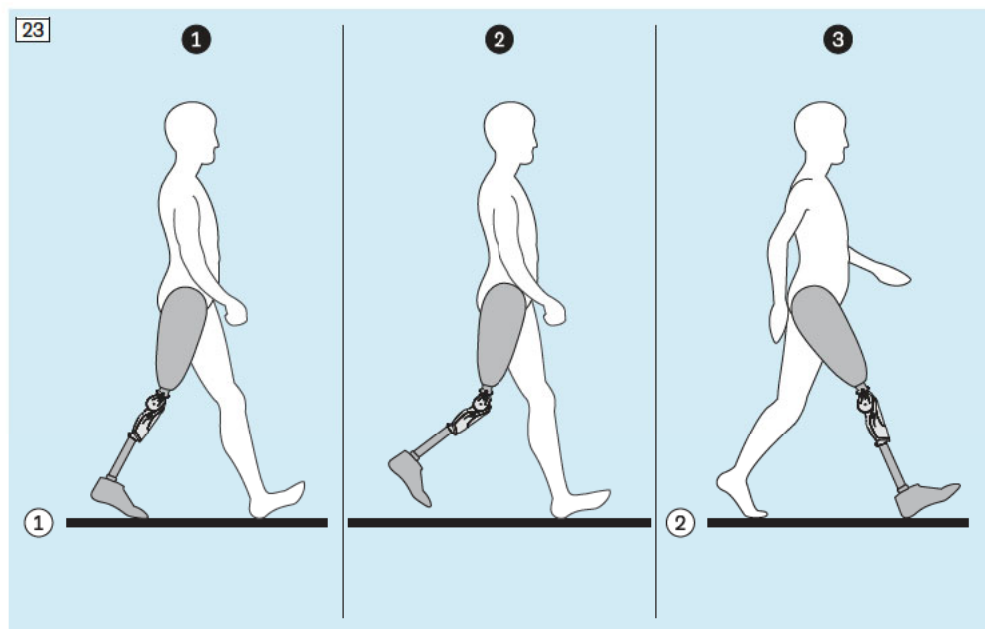

24: ①: Risk of falling – movements can deactivate stance phase flexion resistance

► **CAUTION!** Avoid the following movements and note the section "Exercises and adjustments" (see page 33):

- ②: Hard ground contact in the forefoot area with strong extension (e.g. curb) immediately followed by knee flexion moment
- ③: ① Quick, forceful step forward (e.g. jump) and ② strong hip extension moment at heel strike immediately followed by knee flexion moment
- ④: Walking backward with a load on the prosthetic forefoot, with simultaneous knee flexion moment

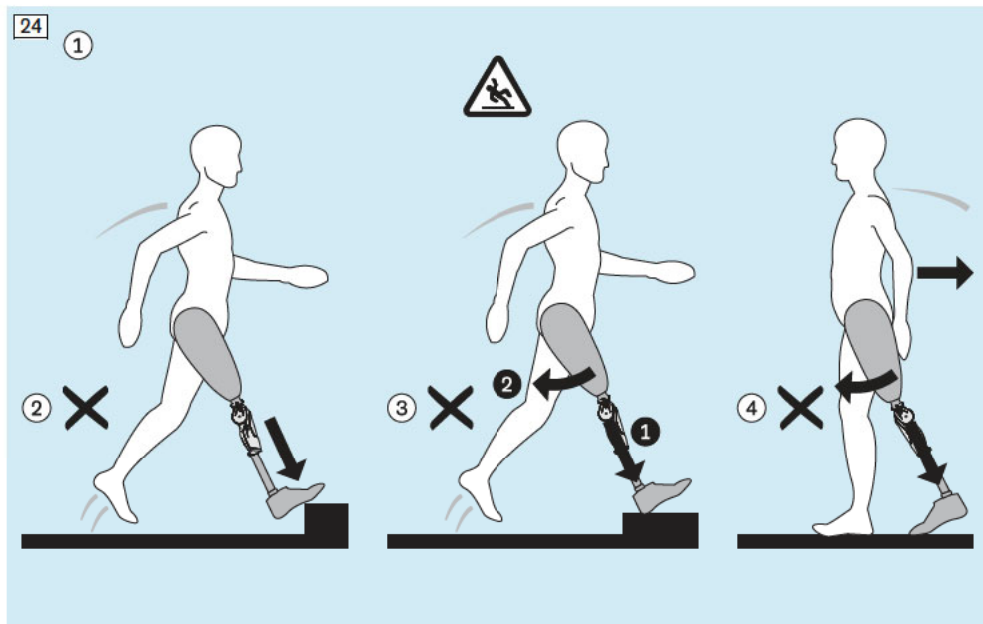

7.4.5 Exercises and adjustments

INFORMATION: As a supplement to this section, the following videos are available for qualified personnel under the QR codes and links provided.



Video "Dynion – Adjustments & settings"

("Dynion – Adjustments & settings" – available languages: English)

<https://youtu.be/ukZ1Q-dgm5A>



Video "Dynion – User training"

("Dynion – User training" – available languages: English)

<https://youtu.be/zMZZBA0-h0>

25: Recommended sequence of the exercises and adjustments

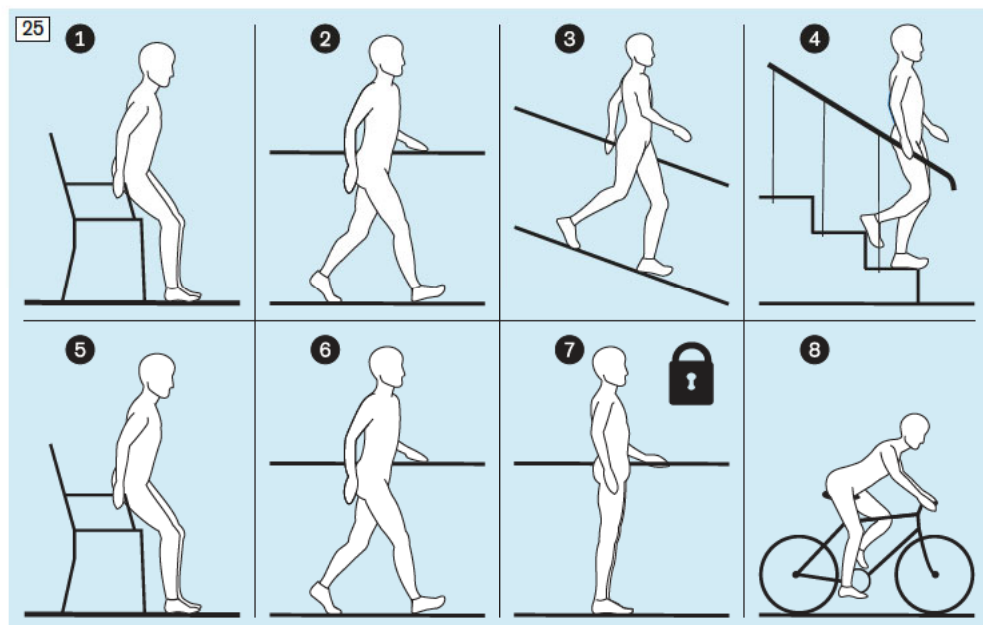

- ▶ **CAUTION!** The various settings of the prosthetic knee joint for the following exercises cannot be adjusted entirely independently of each other. If the settings cannot be fully adjusted to the comfort needs of the patient, the settings must be established primarily based on safety aspects. The extension position has to be reached with every step and at any walking speed.
- ▶ Adapt the settings of the prosthetic knee joint to the patient by means of fine-tuning and exercises.
- ▶ Check the adjustment of the prosthesis settings during normal consultations and as part of the annual safety inspections. Advise the patient to have the prosthesis inspected by qualified personnel if changes in function occur.
- ▶ Observe the recommended sequence of the exercises and settings.

26: 1: **Sitting down**

- ▶ Adjust the stance phase flexion resistance so it provides the patient with adequate safety, yet does not generate excessive resistance.

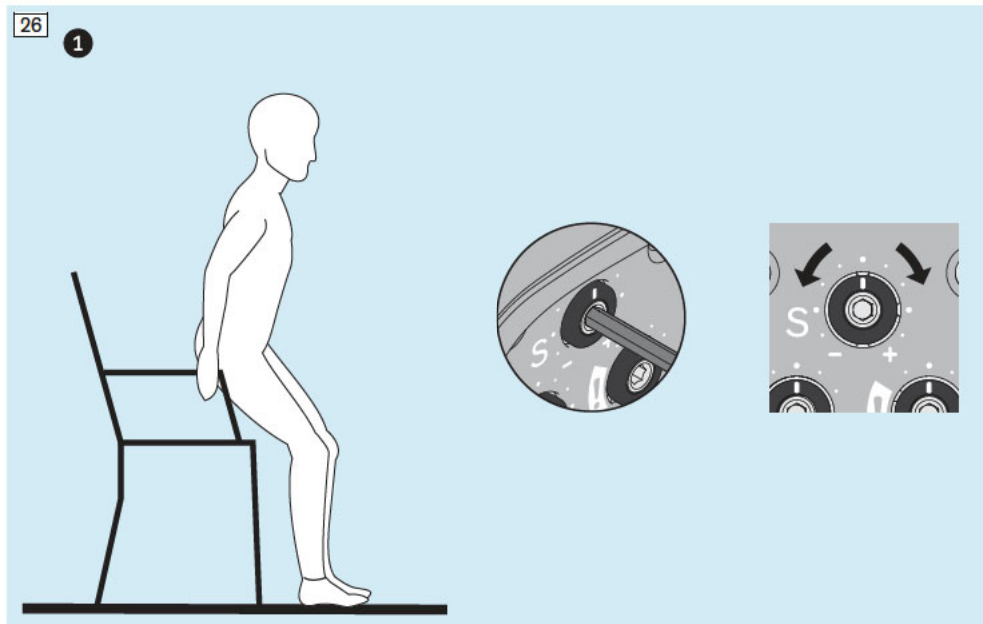

27: 2: Walking

- ▶ **CAUTION!** Since there is a risk of falling when the switching threshold is not adjusted correctly, allow the patient to walk only with safeguards in place.
- ▶ **2.1:** At the start of the walking exercise, increase the switching threshold so the swing phase cannot be enabled.
INFORMATION: The purpose of this setting and the subsequent decrease of the switching threshold is to prevent the stance phase flexion resistance from being deactivated too soon or not at all, and for the patient to gain confidence in the function.
- ▶ Subsequently, decrease the switching threshold in especially small increments (max. 15°) until the swing phase can be initiated. Do not further reduce the switching threshold value after the appropriate setting is found.
- ▶ Adjust the settings first at normal walking speed, then with short, quick steps and finally with long, fast steps.
- ▶ **2.1+2.2+2.3:** Adjust all settings in small increments (max. 15°).
- ▶ Check the effect on the gait pattern after each change.
- ▶ **2.2:** Adjust the swing phase flexion resistance so the lower leg of the prosthesis does not swing through too far in dorsal position and reaches full extension in time for the next heel strike.
- ▶ **CAUTION! 2.3:** Adjust the swing phase extension resistance so the prosthetic knee joint does not swing too hard against the extension stop but reaches full extension in time for the next heel strike. After making adjustments (① – especially for settings in the range marked with!), test the settings while walking with support (e.g. between parallel bars) at different walking speeds, because the switching threshold may have been changed so that stance phase flexion resistance is deactivated under heel load. In this case, increase the switching threshold setting clockwise correspondingly.

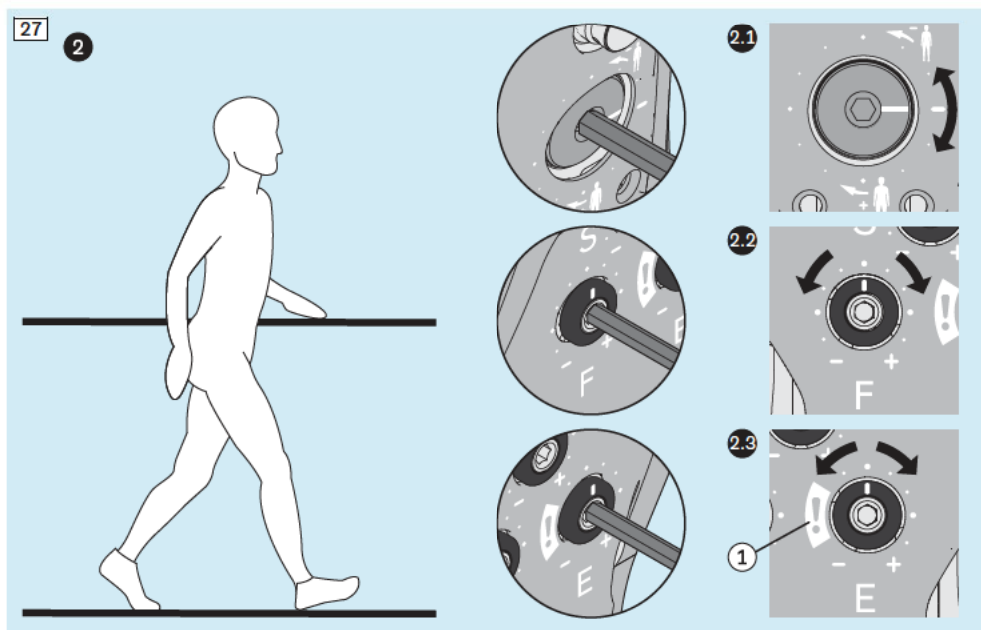

28: **3:** **Walking down ramps**

- ▶ Adjust the stance phase flexion resistance so it provides the patient with adequate safety yet does not generate excessive resistance.
- ▶ **3.2:** During the exercise, also check whether the swing phase extension resistance setting is still appropriate and adjust it if necessary.
- ▶ Set the swing phase extension resistance so that full extension is reached at heel strike if possible.

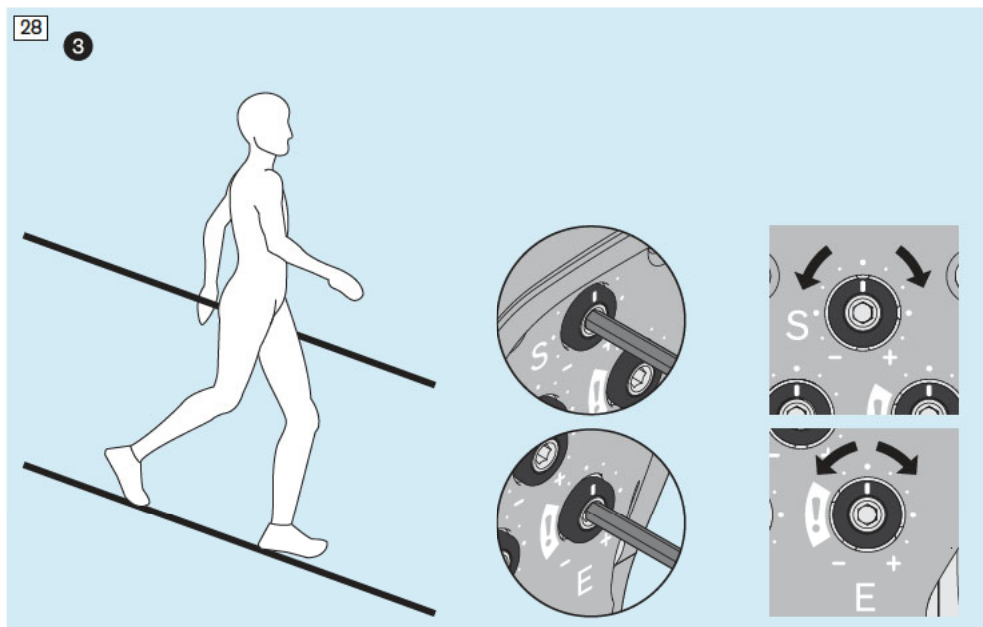

29: 4: Walking down stairs

- ▶ Adjust the stance phase flexion resistance so it provides the patient with adequate safety yet does not generate excessive resistance.
- ▶ Set the swing phase extension resistance so that full extension is reached at heel strike if possible.

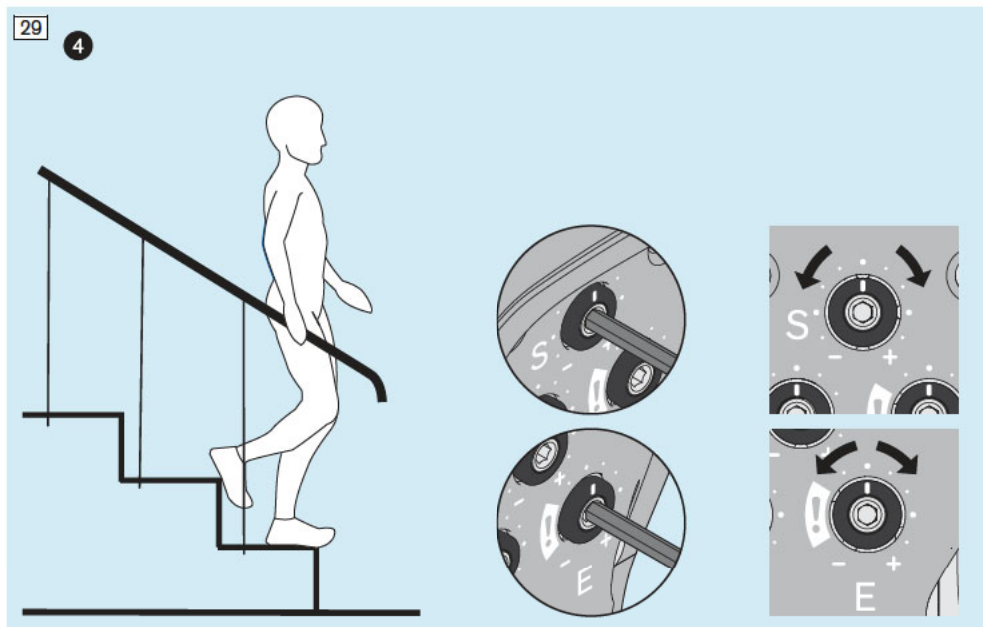

30: 5: **Sitting down (repeat for readjustment)**

- ▶ Check the stance phase flexion resistance for sitting down again and match it with the setting for walking down ramps and stairs.

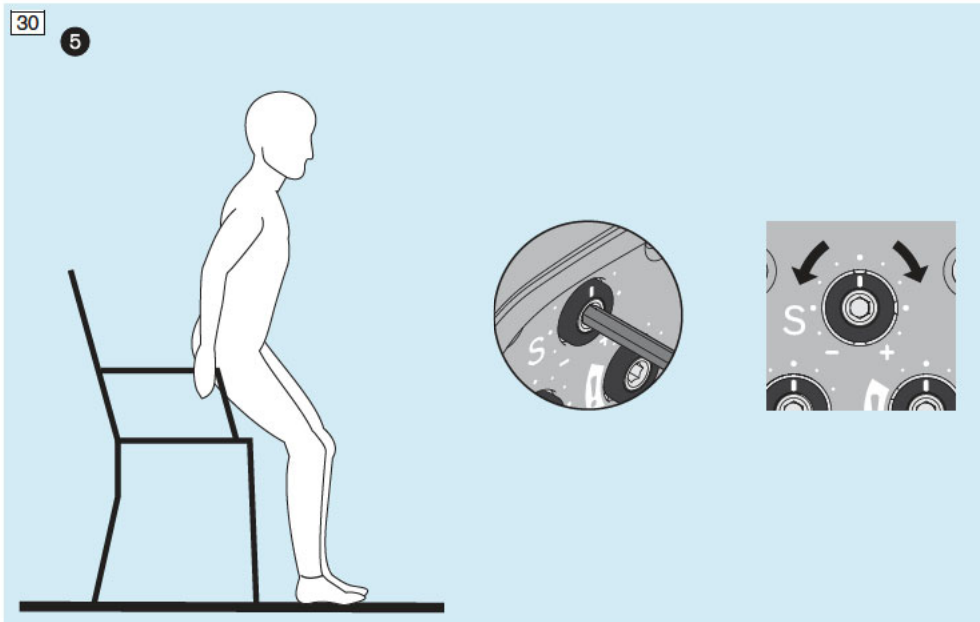

31: 6: Walking (repeat for readjustment)

Since the switching threshold buffer exhibits settlement (especially during the first 10 minutes), it is essential to check again while walking on a level surface whether short, quick steps are still possible or whether the settings have to be readjusted.

- ▶ **6.1:** Check the swing phase flexion resistance again and, if necessary, adjust it in small increments so the lower leg of the prosthesis does not swing through too far in dorsal position and reaches full extension in time for the next heel strike.
- ▶ **6.2:** During the exercise, also check whether the swing phase extension resistance setting is still appropriate and adjust it if necessary.
- ▶ **6.3:** After changing the swing phase extension resistance, check the switching threshold setting and adjust it if necessary.
- ▶ **6.3:** After changing the static alignment during dynamic fitting (e.g. increasing plantar flexion), check the switching threshold setting and adjust it if necessary.

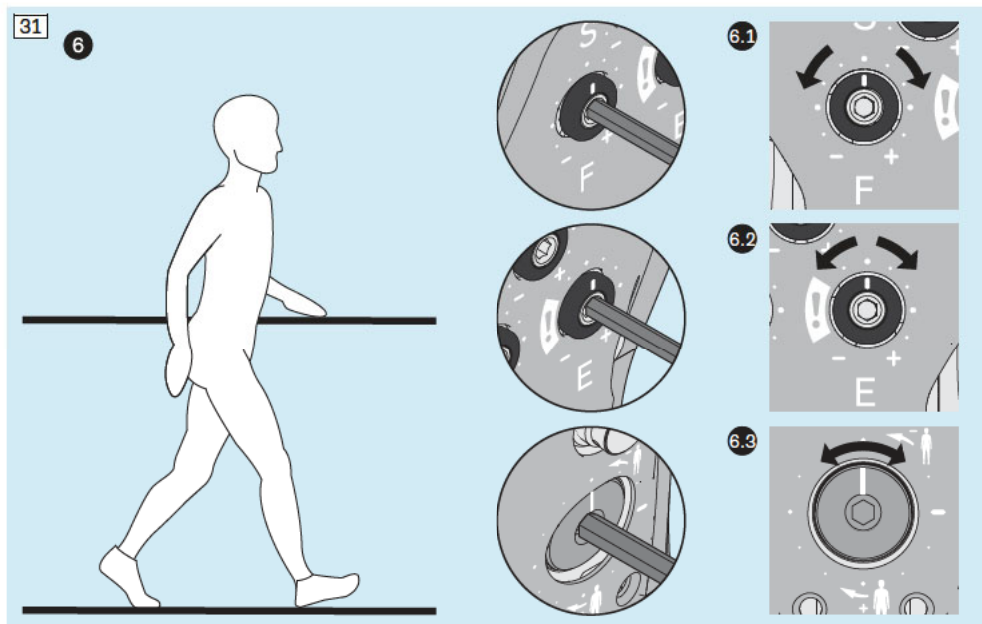

32: For the movements shown in the illustration, there is a risk of falling because they may deactivate the stance phase flexion resistance.

► **CAUTION!** Provide the patient with support (e.g. parallel bars) and have them carefully test at what load stance phase flexion resistance is deactivated. Then discuss with the patient how these movements can be avoided or supported. Examples:

- ①: To avoid a hard ground contact of the prosthetic leg with strong extension (e.g. curb) immediately followed by knee flexion moment, adjust the stride length so the movement is carried out with the sound leg.
- ②: To ① avoid a quick, forceful step forward with the prosthetic leg (e.g. jump) and ② strong hip extension moment at heel strike immediately followed by knee flexion moment, adjust the stride length so the movement is carried out with the sound leg.
- ③: To walk backwards safely, make sure that no load is placed on the prosthetic forefoot with simultaneous hip and knee flexion moment, or walk with the prosthetic knee joint locked.

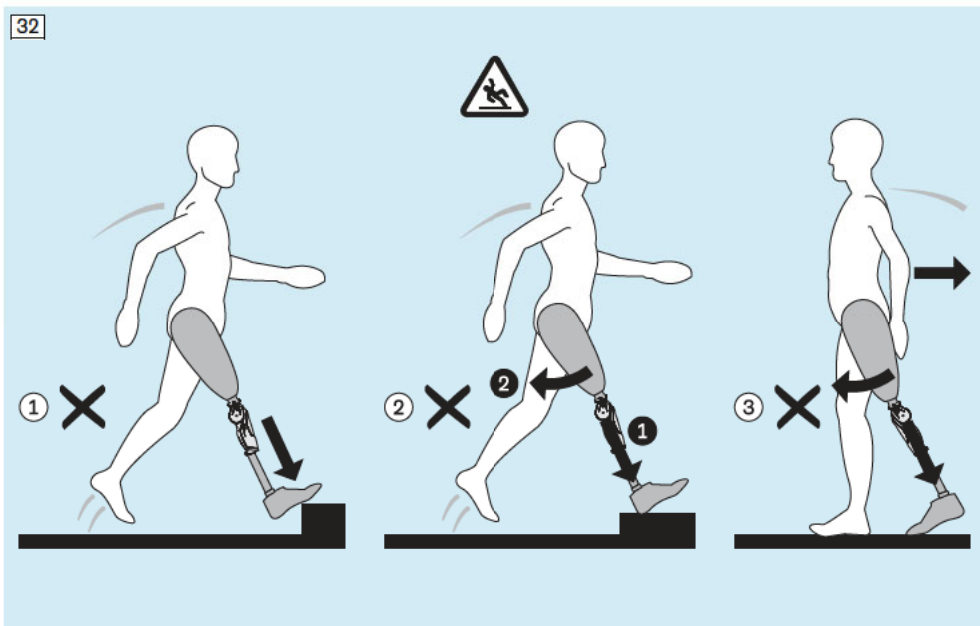

33: 7: Using the lock

► **CAUTION!** In the exercises, practice the reliable use of the control elements by the patient without mix-ups.

Control elements for the patient on the product:

- Push buttons to activate and deactivate the lock
- Push buttons to activate and deactivate cycling mode

Examples of control elements for the patient on optional prosthetic components:

- Release button of the rotation adapter

► Practise using the lock.

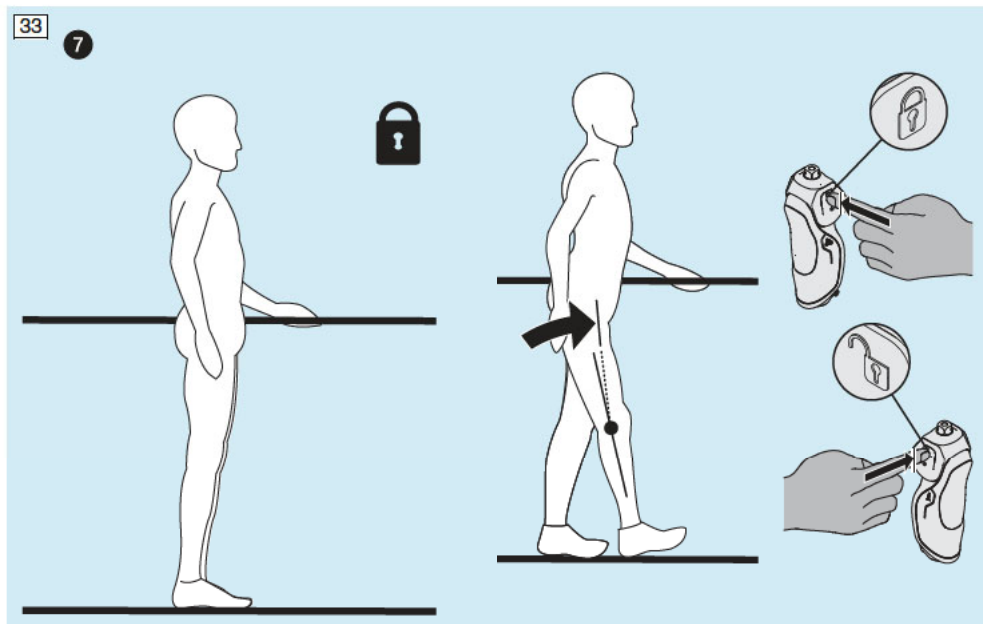

34: 8: Cycling

► Practise using cycling mode.

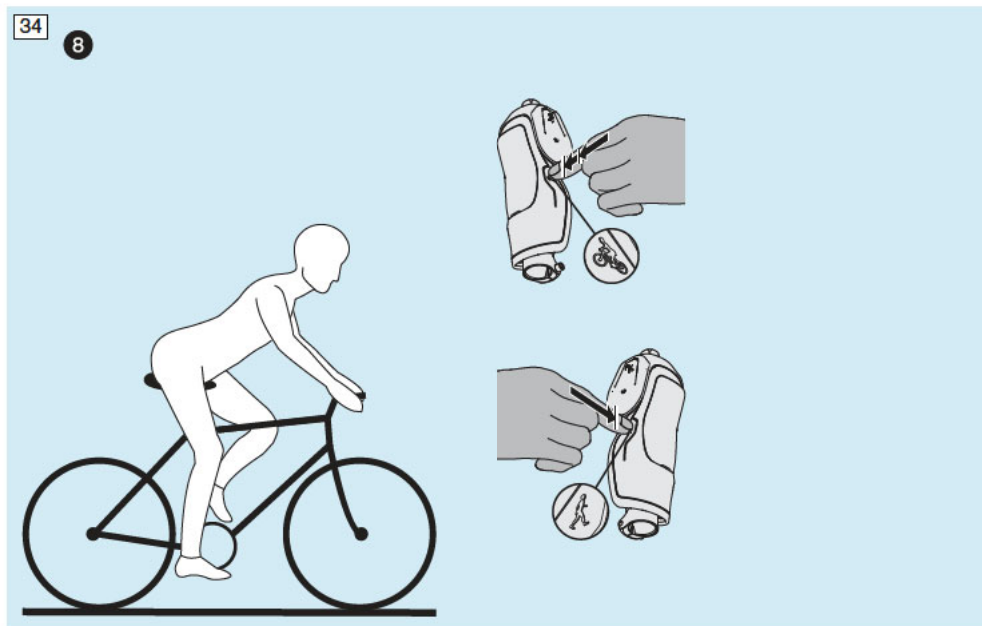

Final inspection



► **CAUTION!** At the end of the exercises and adjustments, check again whether the switching threshold is correctly adjusted while walking at different speeds with support (e.g. between parallel bars).

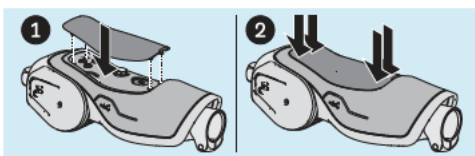

► **NOTICE!** Reattach the cover on the prosthetic knee joint to protect it.

► **CAUTION!** To avoid dangers and product damage, discuss the "Use" section (see page 46) with the patient at the end of the exercises.

7.5 Attaching the cosmetic cover

⚠ CAUTION

Use of highly hygroscopic particles (grease-absorbent substances such as talcum)

Risk of injury, damage to the product due to lack of lubrication

▶ Do not allow the product to come into contact with highly hygroscopic particles.

▶ To reduce friction and to eliminate noise, apply 519L5 Silicone Spray directly onto the contact surfaces of the cosmetic foam cover.

35: The illustration shows the recommended accessories for attaching a cosmetic cover.

35

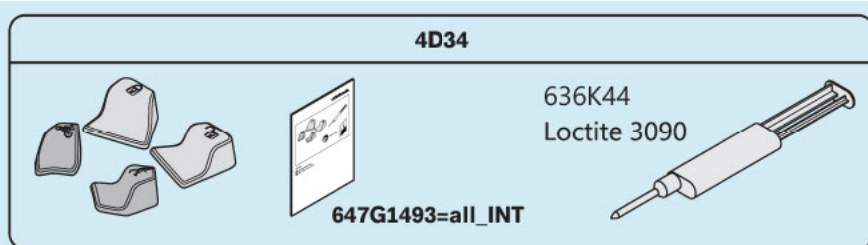

6R8

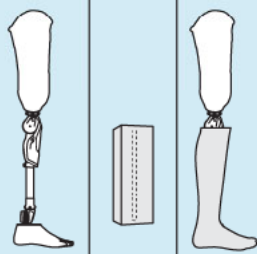

3S107

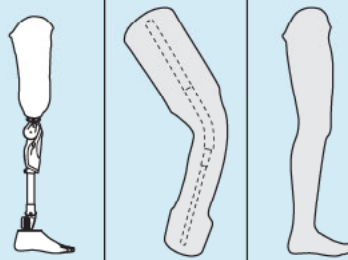

- [36]: Note the following points for attaching the cosmetic cover:
- **CAUTION!** Prepare the cosmetic cover so it does not cause any serious restrictions in the following areas:
 - Flexion movement (example: maximum flexion while kneeling)
 - Safe functioning (example: no unintentional triggering of control elements during movement)
 - Safe operation (example: easy access to the control elements – possible action: holes in the cosmetic cover)
 - ①: Note the important trim values.
 - ②: Attach the push buttons to the product as shown in the illustration.
 - ③: **NOTICE!** ②.1: Do not use too much adhesive ②.2: so it does not run into the slits.
 - ③: To minimise the influence on the swing phase, pull on the cosmetic stocking with the correct tension ratio.
 - ④: Thigh region: Minimum tension
 - ⑤: Lower leg region: Maximum tension
 - After installing the cosmetic cover, repeat the exercises in the section "Exercises and adjustments" (see page 33).
 - **CAUTION!** If necessary, adjust the settings and the cosmetic cover so the patient can use and operate the prosthesis safely.

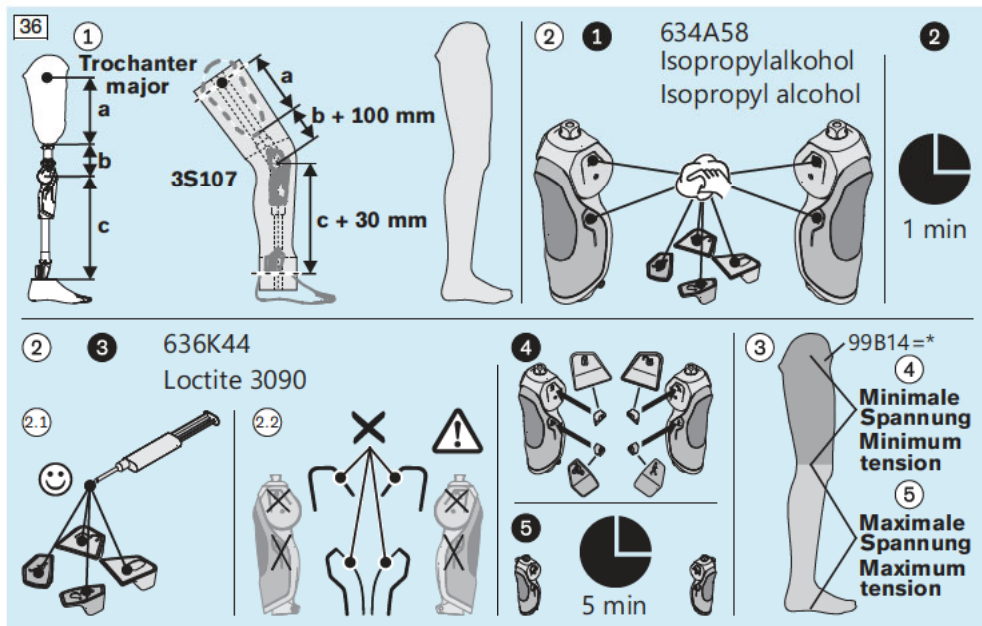

7.6 Finishing the prosthesis

- **37: CAUTION!** To avoid product damage and the risk of falling, finish the prosthesis by replacing set screws that are too short or too long and by tightening all screw connections. In doing so, observe the instructions for use for all prosthetic components regarding installation torque values and thread lock.

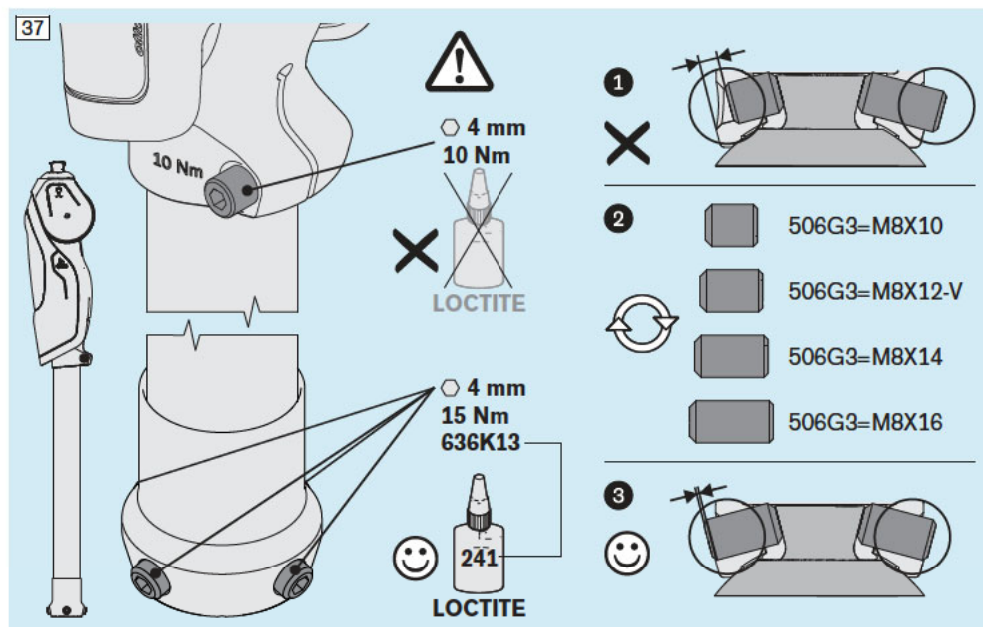

8 Use

INFORMATION

- ▶ Provide the information in the subsections of this section to the patient.

8.1 Information for use

⚠ CAUTION

Overheating of the hydraulics due to increased activity (e.g. extended walking downhill)

Burns, injuries caused by falling due to changes in functionality and damage to prosthetic components

- ▶ **INFORMATION:** If the hydraulics overheat, the stance phase flexion resistance can no longer be deactivated.

Take note of this change in functionality during increased activity, and reduce all activities immediately in this case to allow the overheated product components to cool down.

- ▶ Do not touch overheated product components.
- ▶ If the changes in functionality persist after the hydraulics cool down, have the product checked by authorised qualified personnel.

- ▶ **CAUTION!** Avoid all unsafe movements that unintentionally deactivate the stance phase flexion resistance.

- ▶ **CAUTION!** In case of functional limitations, lock the prosthetic knee joint immediately and have it inspected by qualified personnel.

NOTICE

Mechanical overload

Impaired functionality due to mechanical damage

- ▶ Check the product for damage prior to each use.
- ▶ Do not use the product if its functionality has been impaired.
- ▶ Take any necessary measures (e.g. repair, replacement, inspection by the manufacturer's customer service, etc.).

INFORMATION

Leak in the product's hydraulic system

Environmental damage due to leaking hydraulic oil

- ▶ Before each use, check the product for leaking hydraulic oil.
- ▶ In case of leaks, do not continue using the product and have it repaired promptly.

INFORMATION

The hydraulic oil heats up during use of the product. Storage at temperatures around the freezing point or lower can lead to changes in functionality due to the cold hydraulic oil.

- ▶ If the hydraulic oil is cold, flex and extend the product several times to warm the hydraulic oil before walking.

Lock

⚠ CAUTION

Using the lock

Falling due to non-activation or unintentional deactivation of the lock

- ▶ Each time after activating and deactivating the lock, carefully check the proper functioning of the prosthesis.

- ▶ Lock the prosthetic knee joint before using the prosthesis in wet areas.
- ▶ Adjust the walking speed to the ambient conditions.
- ▶ Make sure the lock is not deactivated or activated through unintentional operation.
- ▶ On wet surfaces, only use a prosthetic foot with a slip-resistant sole.

INFORMATION

Noises may occur due to the play between the extension stop and lock pin when walking with the lock activated. The lock can only be released by actively pressing the deactivation button.

Cycling mode

⚠ CAUTION

Switching between the modes (standard mode <-> cycling mode)

Risk of falling due to changed function (deactivated stance phase flexion resistance in cycling mode)

- ▶ Familiarise yourself with the functionality of the modes by practising extensively.
- ▶ For safe walking, switch back to standard mode each time after using cycling mode (stance phase flexion resistance activated).
- ▶ Carefully verify that the desired mode has actually been activated each time after switching.

Use in water

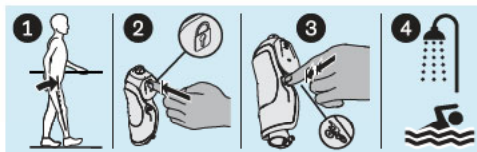

- ▶ **① + ②: CAUTION!** Activate the lock prior to use in water.
- ▶ **③: NOTICE!** Then activate cycling mode to avoid product damage.



- ▶ **⑤: CAUTION!** After use in water, deactivate cycling mode to avoid the risk of falling.
- ▶ **⑥ + ⑦:** Then deactivate the lock.

8.2 Cleaning

CAUTION

Use of unsuitable cleaning agents or disinfectants

Impairment of functionality and damage due to incorrect cleaning agents or disinfectants

- ▶ Only clean the product with the approved cleaning agents.
- ▶ Only disinfect the product with the approved disinfectants.
- ▶ Observe the instructions for cleaning and care.

Permissible cleaning agents and disinfectants

Requirements:

Free of solvents, chlorine and phosphates

INFORMATION

- ▶ Clean the product if it gets dirty.
- ▶ Observe the instructions for cleaning and drying in the section "Environmental conditions" (see page 9).
- ▶ Only use cleaning agents and disinfectants that do not affect the materials of the product. Test the chosen agent for material compatibility in an inconspicuous location.
- ▶ Do not spray the product directly with a pump spray or propellant spray cleaner and disinfectant.
- ▶ Only apply cleaners and disinfectants using a soft, lint-free cloth.
- ▶ Dry with a soft, lint-free cloth. Allow to air dry in order to remove residual moisture.
- ▶ Observe the cleaning instructions for all prosthetic components.

- ▶ **NOTICE!** To properly remove particles of dirt and salt crystals, perform the following steps:
 - Activate cycling mode.
 - Immerse the prosthetic knee joint in clean, fresh water.
 - Move the prosthetic knee joint back and forth in the water (also perform flexion and extension several times) to rinse out particles of dirt and salt crystals.
 - Take the prosthetic knee joint out of the water and allow the remaining water to drain.
 - Dry the prosthetic knee joint with a lint-free cloth and allow it to air dry in order to remove residual moisture.
 - Check the prosthetic knee joint for proper functioning (e.g. flexion and extension, switching threshold, cycling mode and lock).
 - After reaching the maximum period of use for salt water (days per year: 14 – hours per day: 0.5), have the prosthetic knee joint checked by qualified personnel.
 - Deactivate cycling mode.

9 Maintenance

CAUTION

Failure to follow the maintenance instructions

Risk of injuries due to changes in or loss of functionality and damage to the product

► Observe the following maintenance instructions.

- **NOTICE! Do not lubricate and grease the prosthetic joint.**
- **NOTICE! Repair work must be performed exclusively by manufacturer service.**
- Arrange regular maintenance intervals with the patient depending on the level of use.
- Following an individual period for the patient to get accustomed to the prosthesis, check the settings of the prosthetic joint and adapt them to the patient's requirements again as needed.
- The prosthetic components should be inspected after the first 30 days of use.
- Inspect the entire prosthesis for wear during normal consultations.
- Conduct annual safety inspections.
- As part of the safety inspections, inspect the prosthetic joint for wear and proper functionality. Special attention must be paid to the movement resistance, switching threshold, bearing points and development of unusual noises. Full flexion and extension must always be ensured. Make adjustments as needed.
- After using the product in salt water, check it closely for salt residues and signs of corrosion (e.g. set screws).
- Check all product functions to ensure they work reliably (especially the locking function, activated and deactivated cycling mode, flexion and extension, and the switching threshold).
- In case of functional limitations and damage, send the product to the manufacturer's service department.

38: Checking the sacrificial anode

The sacrificial anode ⑤ protects the product against electrochemical corrosion, as it is destroyed rather than the product.

- ▶ Instruct the patient to have the prosthesis inspected as soon as possible in case of visible corrosion (e.g. rust on the set screws that clamp the proximal adapter on the prosthetic knee joint).
- ▶ Check the sacrificial anode during the annual safety inspection.
- ▶ Remove any dirt and crystals from the area around the sacrificial anode prior to inspection.
 - Continue using the product if the sacrificial anode is present as shown in the illustration. (① Entire sacrificial anode present; ② Part of sacrificial anode present – dimension: $< 5\text{ mm}$)
 - **NOTICE!** If the sacrificial anode has been fully or partially destroyed down to the specified dimension as shown in the illustration, have a new sacrificial anode installed by the manufacturer's service department. (③ Sacrificial anode no longer present; ④ Part of sacrificial anode present – dimension: $\geq 5\text{ mm}$)

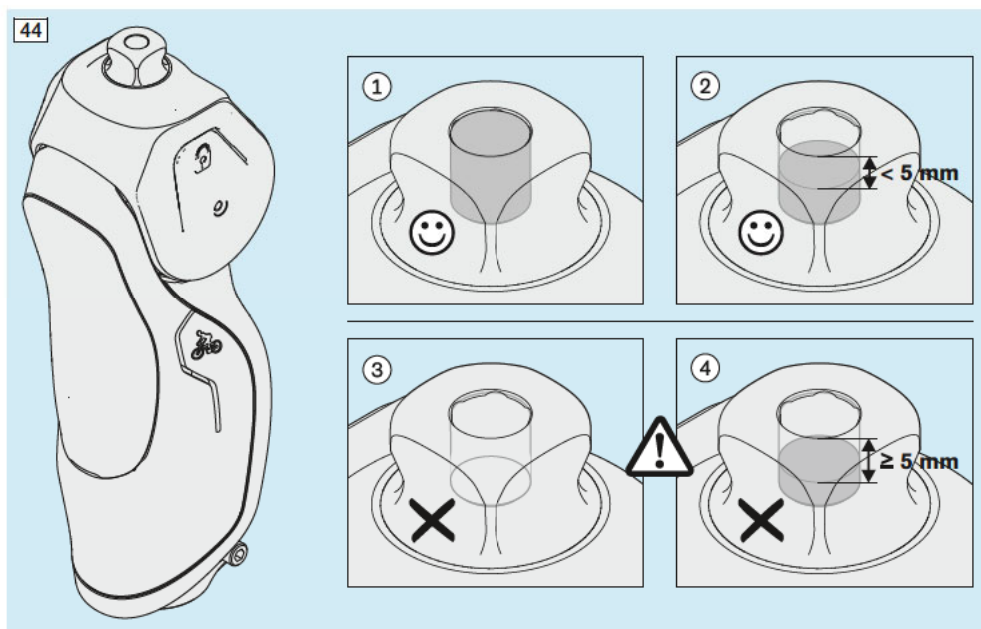

10 Disposal

In some jurisdictions it is not permissible to dispose of the product with unsorted household waste. Improper disposal can be harmful to health and the environment. Observe the information provided by the responsible authorities in your country regarding return, collection and disposal procedures.

11 Legal information

All legal conditions are subject to the respective national laws of the country of use and may vary accordingly.

11.1 Liability

The manufacturer will only assume liability if the product is used in accordance with the descriptions and instructions provided in this document. The manufacturer will not assume liability for damage caused by disregarding the information in this document, particularly due to improper use or unauthorised modification of the product.

11.2 CE conformity

The product meets the requirements of Regulation (EU) 2017/745 on medical devices. The CE declaration of conformity can be downloaded from the manufacturer's website.



Ottobock SE & Co. KGaA
Max-Näder-Straße 15 · 37115 Duderstadt · Germany
T +49 5527 848-0 · F +49 5527 848-3360
healthcare@ottobock.de · www.ottobock.com